

stainless steel trimkit for optional fitment to 30-litre Omega microwave ovens

OTK30XA stainless steel trimkit to suit:

OM301XA microwave oven

OM301GXA microwave oven with grill

OM301CXA microwave oven with grill and convection

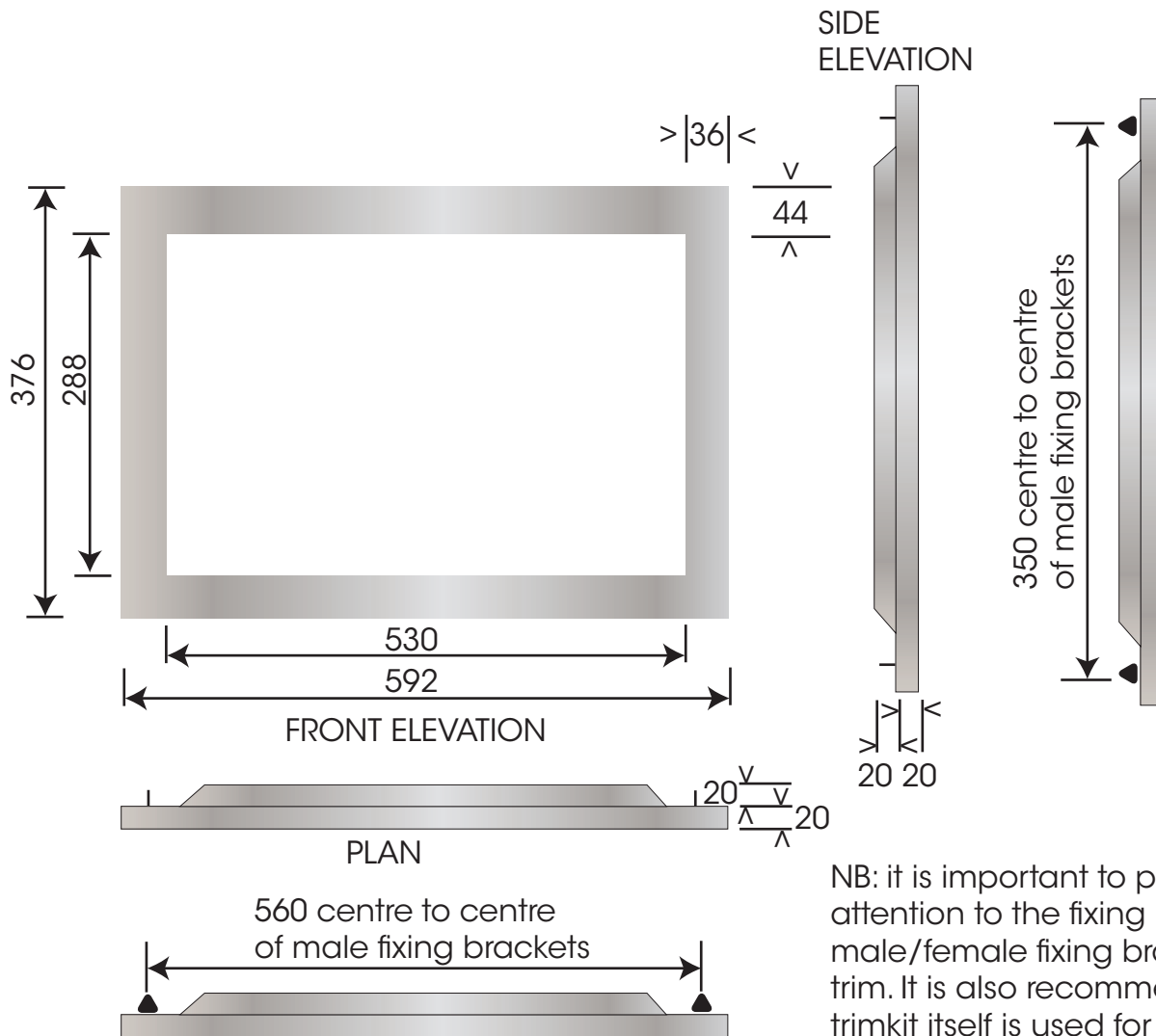

packaged dimensions	630mm x 410mm x 65mm
volume	0.017m ³
gross weight	2.120kg
net weight	1.395kg
supplied	<ul style="list-style-type: none"> • trimkit • brackets, screws, 2 x floor platforms • instructions • floor template