

Table of contents

1. PRECAUTIONS FOR USE	4
2. INSTALLING THE APPLIANCE	6
3. ADAPTATION TO DIFFERENT TYPES OF GAS	10
4. FINAL OPERATIONS	12
5. GETTING TO KNOW YOUR COOKER	13
6. DESCRIPTION OF FRONT PANEL CONTROLS	14
7. USING THE HOB	15
8. USING THE OVEN	16
9. AVAILABLE ACCESSORIES	18
10. ELECTRONIC PROGRAMMER	19
11. CLEANING AND MAINTENANCE	21
12. EXTRAORDINARY MAINTENANCE	23



Thank you for choosing our product.

We advise you to read this manual carefully. It contains all necessary instructions for maintaining unaltered the appearance and functional qualities of the cooker.



*INSTRUCTIONS FOR THE INSTALLER: these are intended for the **authorized person** who is to check the gas supply system and install, commission and test the appliance.*



INSTRUCTIONS FOR THE USER: these provide recommendations for use, a description of the controls and the correct procedures for cleaning and maintaining the appliance.

Precautions for use

1. PRECAUTIONS FOR USE



THIS MANUAL IS AN INTEGRAL PART OF THE APPLIANCE. TAKE GOOD CARE OF IT AND KEEP IT TO HAND THROUGHOUT THE COOKER'S LIFE CYCLE. WE URGE YOU TO READ THIS MANUAL AND ALL THE INFORMATION IT CONTAINS CAREFULLY BEFORE USING THE APPLIANCE. ALSO KEEP ALL THE NOZZLES PROVIDED IN A SAFE PLACE. INSTALLATION MUST BE CARRIED OUT BY QUALIFIED PERSONNEL IN ACCORDANCE WITH THE REGULATIONS IN FORCE. THIS APPLIANCE IS INTENDED FOR HOUSEHOLD USE AND COMPLIES WITH THE **RELEVANT REGULATIONS**. THE APPLIANCE HAS BEEN BUILT TO CARRY OUT THE FOLLOWING FUNCTIONS: **COOKING AND HEATING FOODS**; ALL OTHER USES ARE CONSIDERED IMPROPER.

THE MANUFACTURER DECLINES ALL RESPONSIBILITY FOR IMPROPER USE.

TO BE INSTALLED ONLY BY AN AUTHORIZED PERSON.



NEVER LEAVE PACKAGING RESIDUES UNATTENDED IN THE HOME. SEPARATE WASTE PACKAGING MATERIALS BY TYPE AND CONSIGN THEM TO THE NEAREST SEPARATE DISPOSAL CENTRE.



REPLACED APPLIANCES MUST BE TAKEN TO A SPECIAL GARBAGE COLLECTION CENTRE.



THE APPLIANCE MUST BE CONNECTED TO EARTH IN COMPLIANCE WITH ELECTRICAL SYSTEM SAFETY REGULATIONS.



THE PLUG TO BE CONNECTED TO THE POWER SUPPLY LEAD AND THE RELATIVE SOCKET MUST BE OF THE SAME TYPE AND COMPLY WITH THE RELEVANT REGULATIONS.

THE SOCKET MUST BE ACCESSIBLE AFTER THE APPLIANCE IS BUILT IN.

NEVER DISCONNECT THE PLUG BY PULLING ON THE POWER SUPPLY LEAD.



IMMEDIATELY AFTER INSTALLATION, CARRY OUT A QUICK TEST ON THE APPLIANCE FOLLOWING THE INSTRUCTIONS PROVIDED LATER IN THIS MANUAL. SHOULD THE APPLIANCE NOT FUNCTION, DISCONNECT IT FROM THE SUPPLY AND CALL THE NEAREST TECHNICAL ASSISTANCE CENTRE.

NEVER ATTEMPT TO REPAIR THE APPLIANCE YOURSELF.



AFTER EACH USE OF THE APPLIANCE, ALWAYS CHECK THAT THE CONTROL KNOBS ARE TURNED TO **● (OFF)**



NEVER PLACE FLAMMABLE OBJECTS IN THE OVEN: IF IT SHOULD ACCIDENTALLY BE SWITCHED ON, THIS MIGHT CAUSE A FIRE.



THE NAMEPLATE WITH THE TECHNICAL DATA, SERIAL NUMBER AND MARK IS IN A VISIBLE POSITION INSIDE THE STORAGE COMPARTMENT.

THE PLATE MUST NEVER BE REMOVED.



NEVER PLACE PANS WITH BOTTOMS WHICH ARE NOT PERFECTLY FLAT AND SMOOTH ON THE HOB GRIDS.



DURING USE THE APPLIANCE BECOMES VERY HOT. TAKE CARE NEVER TO TOUCH THE HEATING ELEMENTS INSIDE THE OVEN. TO AVOID BURNS AND SCALDS CHILDREN SHOULD BE KEPT AWAY.



IF THE APPLIANCE IS TO BE POSITIONED ON A PLATFORM IT MUST BE INSTALLED IN SUCH A WAY AS TO PREVENT IT FROM SLIPPING OFF THE FORMER.



INSTALL THE APPLIANCE SO THAT WHEN DRAWERS OR DOORS OF UNITS INSTALLED AT HOB HEIGHT ARE OPENED, ACCIDENTAL CONTACT WITH PANS ON THE HOB IS NOT POSSIBLE.

Precautions for use



WARNING - IN ORDER TO PREVENT ACCIDENTAL TIPPING OF THE APPLIANCE, FOR EXAMPLE BY A CHILD CLIMBING ONTO THE OPEN OVEN DOOR, THE STABILIZING MEANS MUST BE INSTALLED.

PLEASE REFER TO INSTRUCTIONS FOR INSTALLATION.



NEVER USE PANS OR GRIDDLE PLATES WHICH PROJECT BEYOND THE OUTSIDE EDGE OF THE HOB.



THE APPLIANCE IS NOT INTENDED FOR USE BY YOUNG CHILDREN OR INFIRM PERSONS UNLESS THEY HAVE BEEN ADEQUATELY SUPERVISED BY A RESPONSIBLE PERSON TO ENSURE THEY CAN USE THE APPLIANCE SAFELY. YOUNG CHILDREN SHOULD BE SUPERVISED TO ENSURE THAT THEY DO NOT PLAY WITH THE APPLIANCE.



DO NOT SPRAY AEROSOLS IN THE VICINITY OF THIS APPLIANCE WHILE IT IS IN OPERATION.



WHERE THIS APPLIANCE IS INSTALLED IN MARINE CRAFT OR CARAVANS, IT SHALL NOT BE USED AS A SPACE HEATER.



BEFORE THE APPLIANCE IS PUT INTO OPERATION, ALL THE LABELS AND PROTECTIVE FILMS APPLIED INSIDE OR OUTSIDE MUST BE REMOVED.



DO NOT MODIFY THIS APPLIANCE.



DO NOT STORE FLAMMABLE MATERIALS IN THE APPLIANCE STORAGE DRAWER OR NEAR THIS APPLIANCE.



THE INSTRUCTIONS PACKAGED WITH THIS APPLIANCE CONTAIN IMPORTANT INFORMATION ABOUT INSTALLATION AND USE.



UNSUITABLE FOR USE IN MARINE CRAFT, CARAVANS OR MOBILE HOMES, UNLESS EACH BURNER IS FITTED WITH A FLAME SAFEGUARD



IN CASE OF SERVICE, CONTACT YOUR NEAREST SERVICE AGENT OR DISTRIBUTOR LISTED ON THE WARRANTY CARD.



The manufacturer declines all responsibility for injury or damage caused by failure to comply with the above regulations or deriving from tampering with even just one part of the appliance and the use of non-original spare parts.



2. INSTALLING THE APPLIANCE



It is the law that all gas appliances are installed by **authorised persons**. Clearance around the cooker must comply with the requirements of AS5601.

2.1 Electrical connection



After making the electrical and gas connections, level the the appliance on the ground by means of its four adjustable feet. For good cooking results, the appliance must be properly levelled. Depending on the model you have purchased, the foot height adjustment range may vary from 70 to 95 mm and from 110 to 160 mm. These heights refer to the distance between the highest point of the foot (fixed part) and the lowest point (movable part which rests on the floor).

2.2 Electrical connection

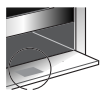

Make sure that the power line voltage matches the specifications indicated on the rating plate located inside the storage compartment.

This rating plate must never be removed.

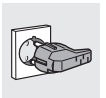

The plug on the end of the power supply cable and the wall socket must be of the same type (in compliance with the relevant national standards). Check that the power supply line is properly earthed. The use of reductions, adapters or junctions is not recommended.



The appliance's power supply line must be fitted with an omnipolar breaking device with contact gap of at least **3 mm**, located in an easily accessible position close to the appliance itself.



The wire section on the cable must not be less than 1.5 mm^2 (3 x 1.5 cable), keeping in mind that the end to be connected to the cooker must have the ground wire (yellow-green) longer by at least 20 mm. Use only the special cables available at our Service Centres.

For operation on **220-240V~**: use an H05V2V2-F type three-core cable (3 x 1.5 mm^2).

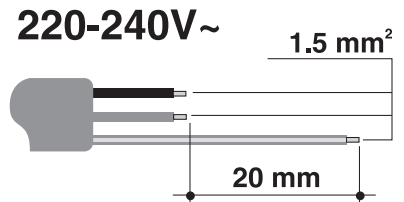

The manufacturer declines all responsibility for damage to persons or things caused by non-observance of the above prescriptions.

Overall dimensions: location of gas and electrical connection points (all measures in mm).

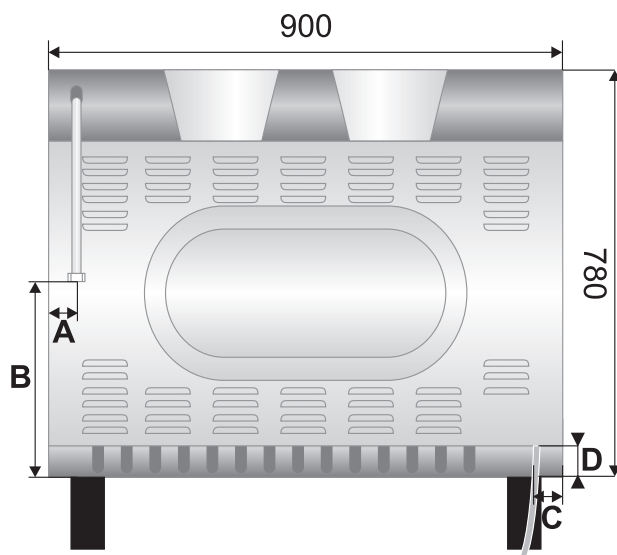

	90 cm
A	60
B	600
C	110
D	145



Instructions for the installer

2.3 Gas connection

This appliance is suitable for installation with Natural Gas or ULPG (propane). Refer to page 13 for the relevant burner pressure and appropriate injector sizes. When the appliance is to be connected to Natural Gas then the pressure regulator supplied must be fitted to the gas inlet. A test point (for checking the gas pressure) is supplied either with the regulator or as a separate fitting in the case of LPG (propane) appliances.

Connection of the appliance to the gas supply must be in accordance with the requirements of AS5601. A ½" BSP connector at the inlet is recommended and the gas supply line to the appliance must be of adequate length to allow sufficient withdrawal of appliance for service or disconnection and be:

- 1 annealed copper pipe or;
- 2 Flexible hose according to AS/NZ1869 & be at least Class "B", 10 mm diameter, max length 1000 mm.

The cooker must be installed with provision to allow the gas to be turned off and disconnected for servicing and removal of the appliance as required from the gas supply.

Before the cooker is operated make certain all relevant parts are placed in the correct position.

When the installation is completed the installation connections of cooker will require to be leak tested, the burner operating pressure and flame checked and adjusted.

Warranty service calls do not cover these adjustments!

To check the operating pressure of the appliance it is recommended at least 2 large size burners are used. Ensure appliance is secured to wall when installation is completed.

N.G. A regulator must be fitted to the ½ BSP thread at the rear of the appliance. An approved manual shut-off valve must be installed. The N.G. regulator must be checked and adjusted to 1.0kPa after installation.

U.L.P.G. Can be connected to the inlet fitting directly. The pressure must be checked to ensure it is operating at 2.75kPa. A separate test point fitting must be installed between the piping & the appliance for the pressure to be checked to ensure it is operating at 2.75kPa.

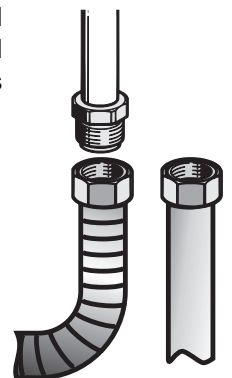
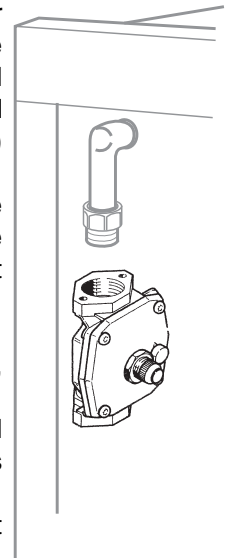

2.4 Ventilation requirements



Caution – This cooker may only be installed and operated in rooms permanently ventilated in accordance with current regulations. For proper operation of a gas appliance it is essential for the air necessary for combustion of the gas to be able to flow naturally into the room. Air must flow directly into the room through openings in its outside walls. This (these) opening (s) must have a free passage cross-section of at least 100 cm², or 200 cm² for appliances not equipped with gas safety device. These openings must be constructed so that they cannot be obstructed indoors or outdoors, and should preferably be close to the floor on the side opposite to the combustion gas discharge point. If it is not possible to make the openings in the room where the cooker is installed, the necessary air may be taken from an adjoining room, provided it is not a bedroom or a room with fire risk.



2.5 Clearance above and around domestic cookers

Extract from AS5601

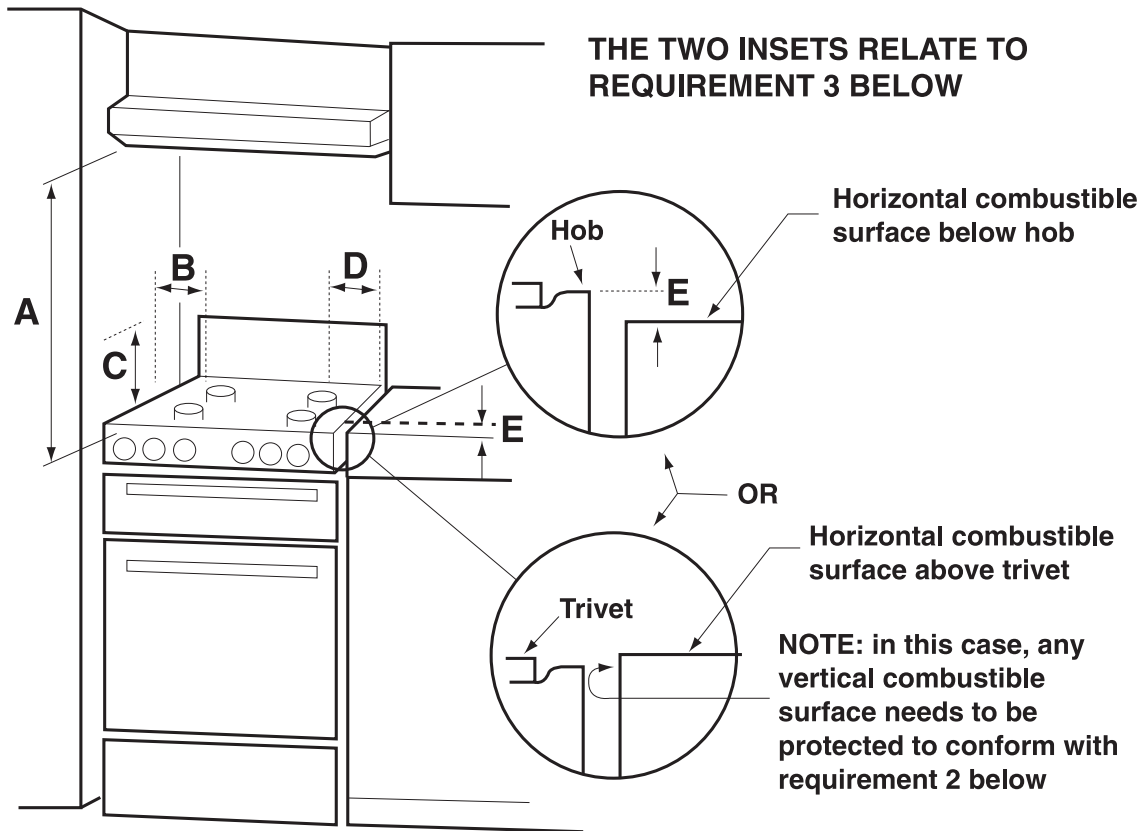

REQUIREMENTS

- 1 Overhead clearances – (Measurement A)
Range hoods and exhaust fans shall be installed in accordance with the manufacturer's instructions. However, in no case shall the clearance between the highest part of the hob of the cooking appliance and a range hood be less than 600 mm or, for an overhead exhaust fan, 750 mm. Any other downward facing combustible surface less than 600 mm above the highest part of the hob shall be protected for the full width and depth of the cooking surface area in accordance with Clause 5.12.1.2. However, in no case shall this clearance to any surface be less than 450 mm.
- 2 Side clearances – (Measurements B & C)
Where B, measured from the periphery of the nearest burner to any vertical combustible surface, is less than 200 mm, the surface shall be protected in accordance with Clause 5.12.1.2 to a height C of not less than 150 mm above the hob for the full dimension (width or depth) of the cooking surface area. Where the cooking appliance is fitted with a 'splashback', protection of the rear wall is not required.
- 3 Additional requirements for Freestanding and Elevated Cooking Appliances – (Measurements D & E)
Where D, the distance from the periphery of the nearest burner to a horizontal combustible surface is less than 200 mm, then E shall be 10 mm or more, or the horizontal surface shall be above the trivet. See insets above.

NOTES

- 1 Requirement 3 does not apply to a freestanding or elevated cooking appliance which is designed to prevent flames or the cooking vessels from extending beyond the periphery of the appliance.
- 2 The 'cooking surface area' is defined as that part of the appliance where cooking normally takes place and does not include those parts of the appliance containing control knobs.
- 3 For definition of hob, see Clause 1.4.64.
- 4 For definition of trivet, see Clause 1.4.109.
- 5 Consideration is to be given to window treatments when located near cooking appliances. See Clause 5.3.4.



Instructions for the installer

2.6 Instruction for wall fixing

1 Fasten the two wall brackets to the wall taking care to comply with the centre distances and measurements indicated in the images below. The dimensions are given in mm.

A= 457 / B = 220,5

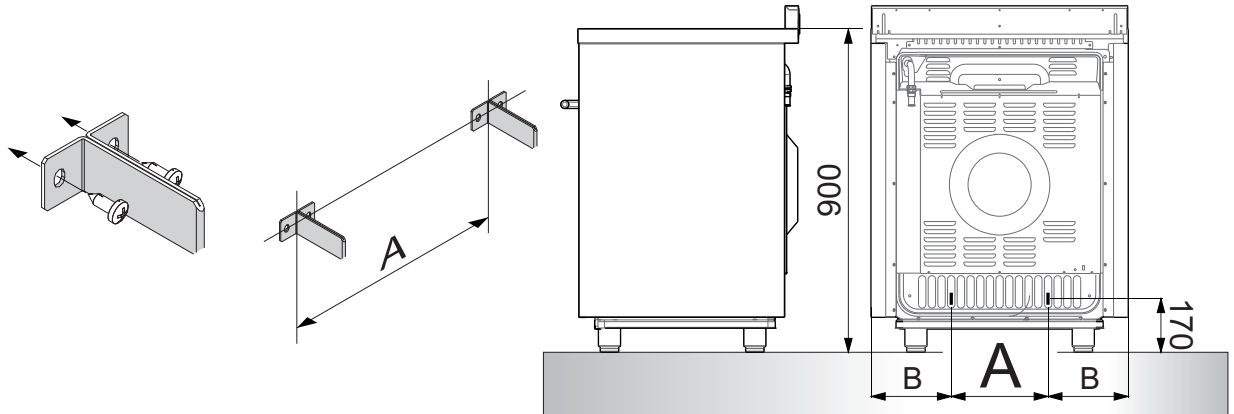

2 Attach the chain to the cooker

3 Stretch out the chain attached to the cooker horizontally so that the other end touches the wall.

4 Mark the wall in the position where the hole is to be drilled.

5 Drill the hole, insert a wall plug and attach the chain.

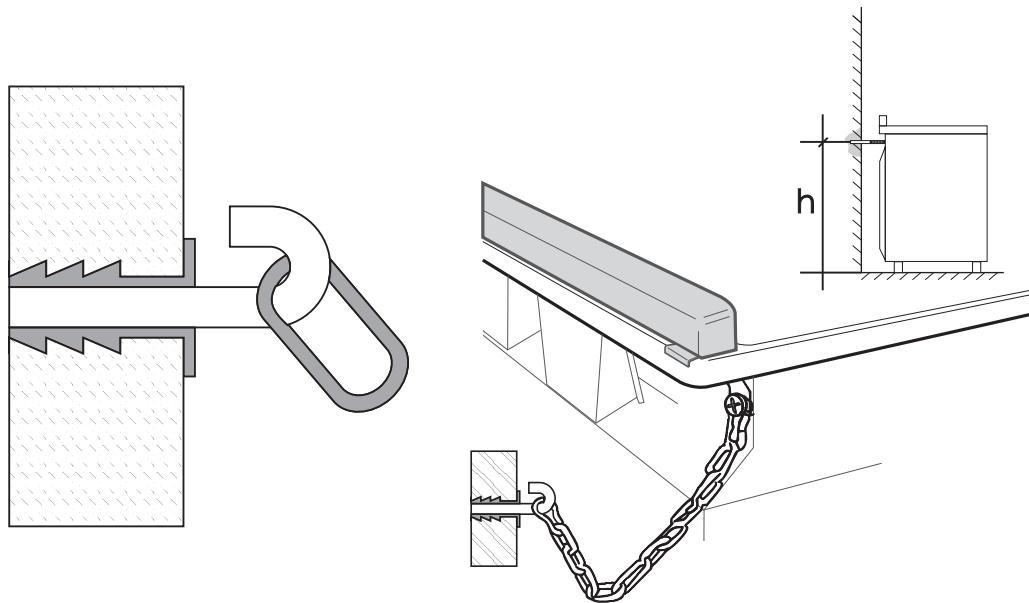

6 Once these operations are completed, push the appliance against the wall taking care to insert the wall brackets correctly in the slots on the back of the cooker.

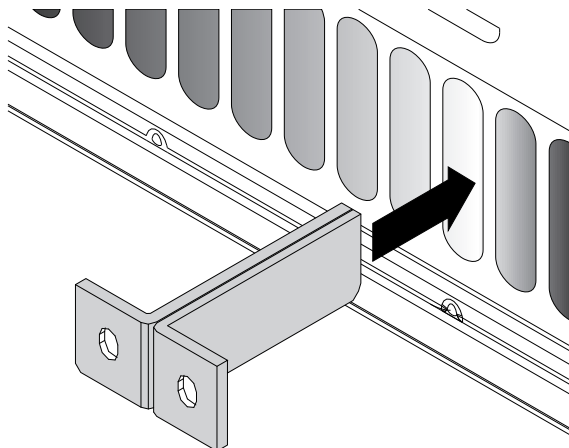



3. ADAPTATION TO DIFFERENT TYPES OF GAS

Before performing any operations requiring access to powered parts, switch off the power supply to the appliance.



The cooker hob is preset for **natural gas** at a pressure of 1.0 KPa. In the case of operation with other types of gas the burner nozzles must be changed and the minimum flame adjusted on the gas taps. To change the nozzles, proceed as described below.

3.1 Changing nozzles

This operation does not require the primary air to be adjusted.

- 1 Extract the grids and remove all the caps and flame-spreader crowns;
- 2 Unscrew the burner nozzles with a 7 mm socket wrench;
- 3 Replace the nozzles according to the type of gas to be used and the description in paragraph "3.2 Burner and nozzle characteristics table";
- 4 Replace the burners in the correct position.

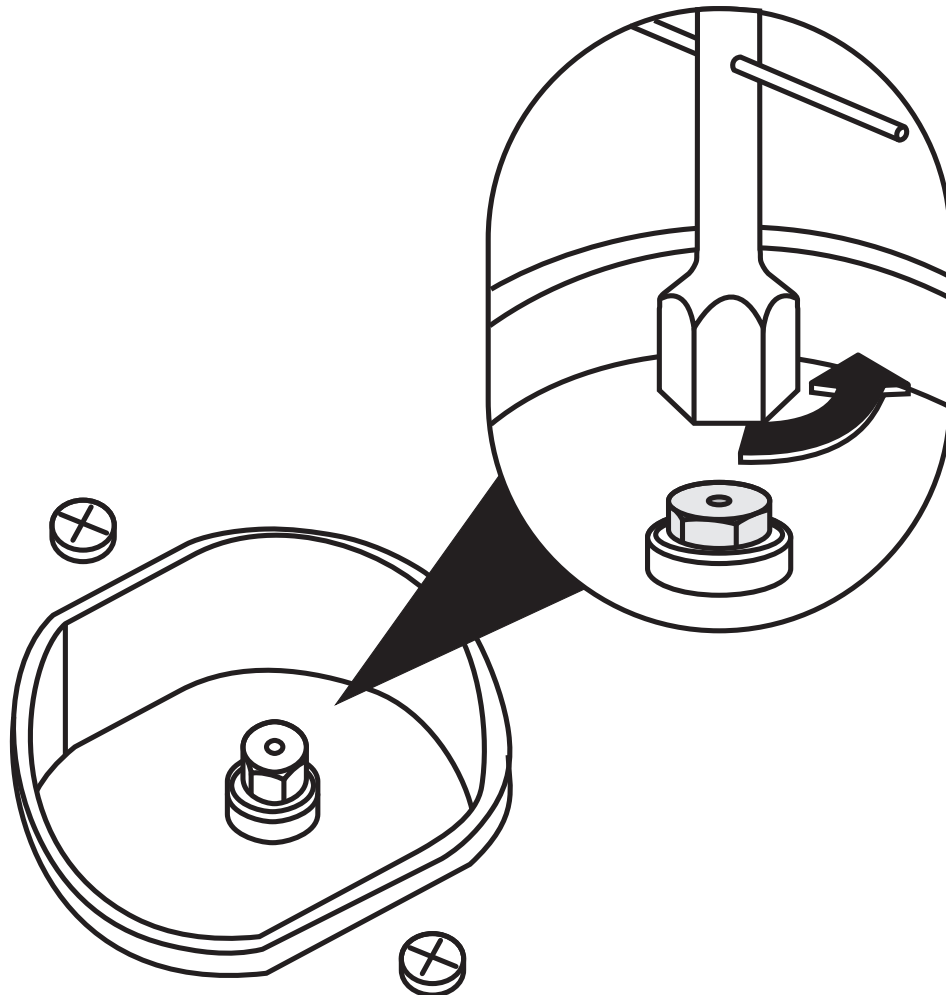



Instructions for the installer

3.2 Burner and nozzle characteristics table

Burner	ULPG (PROPANE) – 2.75 KPa		
	Nominal gas consumption (MJ/h)	Turn-down gas consumption (MJ/h)	Injector (mm)
Auxiliary (1)	3.9	1.5	0.54
Semi rapid (2)	6.3	1.5	0.68
Rapid (3)	10.8	2.7	0.88
Ultra-rapid (4)	15.0	5.4	1.05

Burner	NG (NATURAL GAS) – 1.0 KPa		
	Nominal gas consumption (MJ/h)	Turn-down gas consumption (MJ/h)	Injector (mm)
Auxiliary (1)	3.9	1.5	0.90
Semi rapid (2)	7.5	1.5	1.20
Rapid (3)	12.0	2.7	1.55
Ultra-rapid (4)	15.8	5.4	1.85

3.3 Arrangement of the burners on the hob

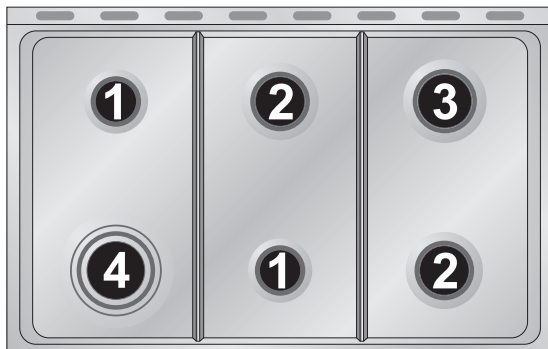

BURNERS

min. and max. Ø (in cm)

1. Auxiliary	12 - 14
2. Semi-rapid	16 - 24
3. Rapid	18 - 26
4. Ultra-rapid	18 - 26

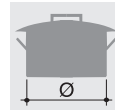



4. FINAL OPERATIONS



After changing the nozzles, put the pan stands, the burner caps and flame diffuser rings back in place.



After adjusting for use of a gas other than the gas used for testing the appliance, replace the gas setting label on the appliance with the label for the new gas. The label is supplied in the bag with the nozzles.

4.1 Regulation of the hob burner minimum level for natural gas

Light the burner and turn it to the minimum position Δ . Extract the gas tap knob and turn the adjustment screw at the side of the tap rod until the correct minimum flame is achieved.

Refit the knob and verify that the burner flame is stable (turning the knob rapidly from the maximum to the minimum position the flame must not go out). Repeat the operation on all the gas taps.

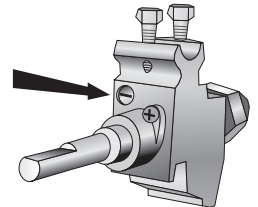

For models with valves, keep the knob at minimum level for about 1 minute to keep the flame lit and to activate the safety device.

4.2 Regulation of the hob burner minimum level for ULPG



In order to adjust the minimum with ULPG, the screw at the side of the tap rod must be turned clockwise all the way. The bypass diameters for each individual burner are shown in paragraph "3.2 Burner and nozzle characteristics table". Once the regulation has been completed, restore the seal on the by-passes using paint or similar materials.



Instructions for the user

5. GETTING TO KNOW YOUR COOKER

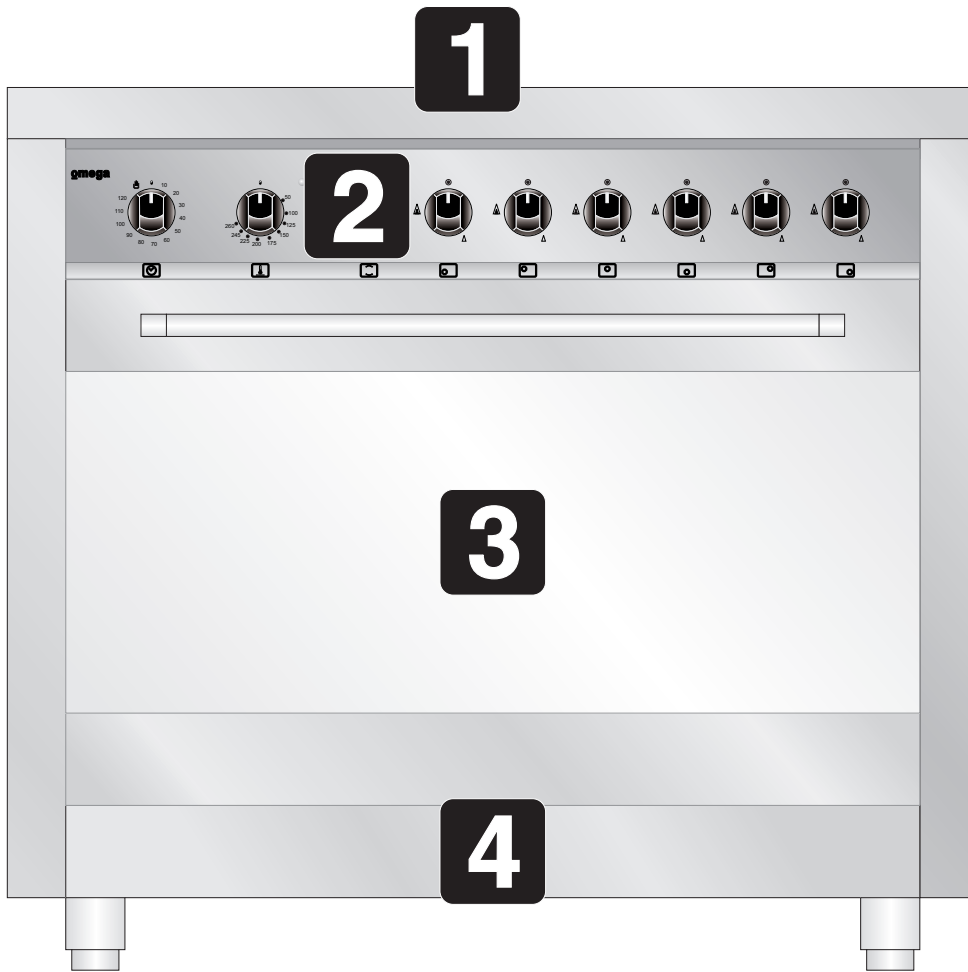









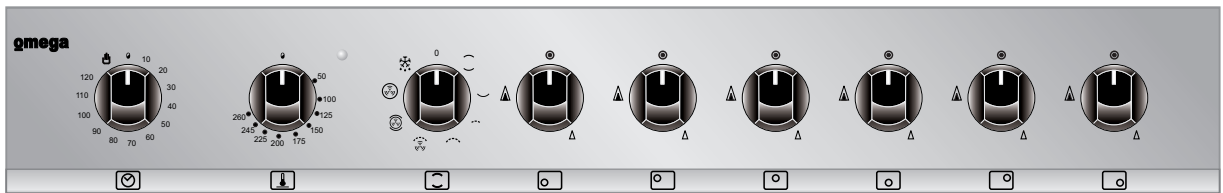

- 1** HOB
- 2** CONTROL PANEL
- 3** OVEN/MAIN OVEN
- 4** FOOD WARMER COMPARTMENT



6. DESCRIPTION OF FRONT PANEL CONTROLS



All the control and monitoring devices are clearly in view on the front panel. The symbols used are described in the table below.



	OVEN THERMOSTAT		CENTRAL RIGHT-HAND BURNER
	FUNCTION SELECTOR KNOB		FRONT CENTRAL BURNER
	TIMER KNOB		REAR RIGHT-HAND BURNER
	FRONT LEFT-HAND BURNER		FRONT RIGHT-HAND BURNER
	REAR LEFT-HAND BURNER		

HOB BURNER CONTROL KNOB

To light the flame, press the knob and turn it anti-clockwise to the minimum flame symbol .

To adjust the flame, turn the knob to the zone between the maximum () and the minimum () settings.

To turn off the burner, turn the knob to the  position.

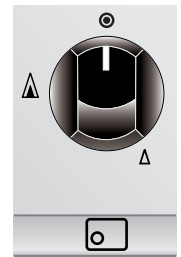

TIMER KNOB

This knob allows to select manual cooking or the timer: the oven switches off automatically at the end of cooking.

If no cooking duration is selected, the timer knob must be positioned on the symbol  .

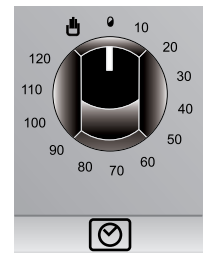

THERMOSTAT KNOB

The cooking temperature is selected by turning the knob clockwise to the required setting, between **50°** and **260°**°C.

The light comes on to indicate that the oven is heating up.

This light goes out when the set temperature is reached. It flashes at regular intervals to indicate that the temperature inside the oven is being kept constantly at the set level.

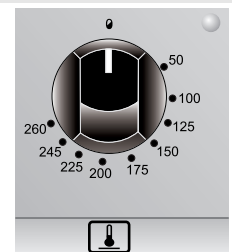











Instructions for the user

FUNCTION SELECTOR KNOB

The electric oven's various functions are suitable for different cooking modes. After selecting the function required, set the cooking temperature using the thermostat knob.



- | | | | |
|---|---------------------------------|---|--|
|  | TOP AND BOTTOM HEATING ELEMENTS |  | GRILL ELEMENT + VENTILATION |
|  | BOTTOM HEATING ELEMENTS |  | TOP + BOTTOM HEATING ELEMENTS + VENTILATED HEATING ELEMENT |
|  | WIDE GRILL ELEMENT |  | VENTILATED HEATING ELEMENT |
|  | GRILL ELEMENT |  | DEFROSTING |



7. USING THE HOB

7.1 Lighting the hob burners



Before lighting the hob burners, check that the flame-spreader crowns are correctly in place with their respective burner caps, making sure that the holes **A** in the flame-spreaders are aligned with the plugs and thermocouples. Before lighting the burners **lift the glass lid**; before closing it again, turn off all the burners and wait for them to cool.



The optional grid **B** is for use with woks. To prevent damage to the hob, the cooker comes complete with a raised pan stand **C** for use underneath pans more than 26 cm in diameter. The pan stand **C** supplied is for use even with small pans.

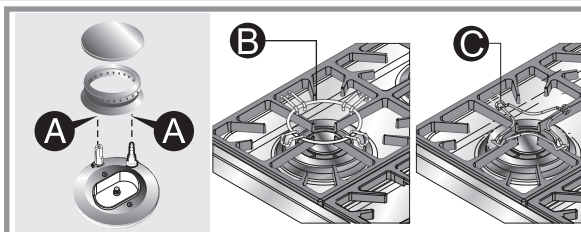

The burner each knob controls is shown next to the knob. The appliance is equipped with an electronic ignition device. Simply press the knob and turn it anti-clockwise to the minimum flame symbol Δ , until the burner lights. Keep the knob pressed down for a few seconds to allow the thermocouple to heat up. The burner may go out when the knob is released: in this case, the thermocouple has not heated up sufficiently. Repeat the operation, keeping the knob pressed down for longer. This is not necessary on burners not equipped with thermocouple.

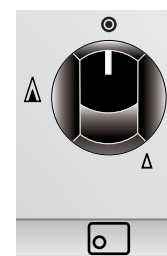

If the burners should go out accidentally a safety device will be tripped about 20 seconds later, cutting off the gas supply even if the gas tap is open.

7.2 Practical hints for using the hob burners



For better burner efficiency and to minimise gas consumption, use pans with lids and of suitable size for the burner, so that flames do not reach up the sides of the pan (see paragraph "7.3 Pan diameters"). Once the contents come to the boil, turn down the flame far enough to prevent the liquid from boiling over. To prevent burns or damage to the hob during cooking, all pans or griddle plates must be placed inside the perimeter of the hob. All pans must have smooth, flat bottoms. Take the greatest care when using fats or oils since they may catch fire if overheated. If the flame accidentally goes out, turn off the control knob and wait at least 1 minute before trying to re-light the burner.

7.3 Pan diameters

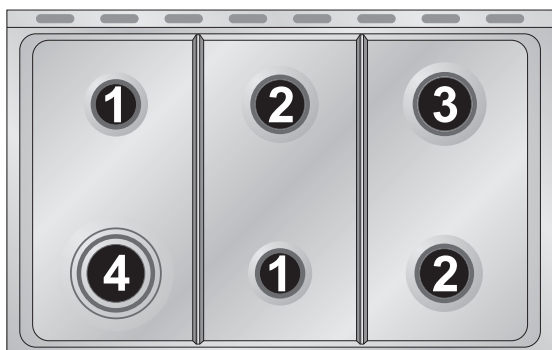

BURNERS min. and max. Ø (in cm)

1. Auxiliary	12 - 14
2. Semi-rapid	16 - 24
3. Rapid	18 - 26
4. Ultra-rapid	18 - 26

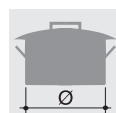



Instructions for the user

8. USING THE OVEN



When the oven is used for the first time, it should be heated to the maximum temperature (250-220°C) for long enough to burn off any oily residues left by the manufacturing process, which might contaminate foods with unpleasant smells.



Before using the oven, check that the display is showing the  symbol.



The appliance becomes very hot during use. oven gloves should always be worn.

8.1 Precautions and general advice

When the oven and grill are used for the first time, they should be heated to the maximum temperature for long enough to burn off any oily residues left by the manufacturing process, which might contaminate foods with unpleasant smells. After an interruption in the electricity supply, the display flashes at regular intervals, showing . For setting instructions, see paragraph " ".



Oven accessories which may come into contact with foods are made from materials compliant with the relevant regulations.



During cooking, do not cover the bottom of the oven with aluminium foil, and do not place pans or trays on it; this may damage the enamel coating. If you wish to use greaseproof paper, place it so that it will not interfere with the hot air circulation inside the oven.



To avoid unpleasant contact with any steam inside the oven, open the door in two stages: hold it half-open (about 5 cm) for 4-5 seconds, then open it completely. If you have to carry out any procedures on foods, leave the door open for as short a time as possible to prevent a drop in the oven temperature which will impair the cooking results.





8.2 Oven Light

It comes on when the function selector is turned to any setting.

8.3 Cooling system

A cooling system comes into operation a few minutes after the oven is switched on. The fan causes a steady outflow of air from above the door which may continue for a brief period of time even after the oven has been turned off.

8.4 Using the electric grill

For short cooking procedures, such as final browning of cooked meat, select the static grill function  /  and turn the thermostat knob to the maximum temperature setting. The fan grill function (on some models only) allows real cooking processes to be carried out, thanks to the forced fan system that ensures the heat penetrates inside the food. For this type of cooking operation, select the fan grill function  and use the function selector knob to set the ideal cooking temperature (in all cases no more than 200°C).



8.5 Using the grill



When the oven has come on (the red light comes on to confirm this), leave it to heat up for 5 minutes before placing foods inside.

Seasonings must be added to foods before cooking. Foods should also be coated with oil or melted butter before cooking. Use the oven tray to collect juice.

The foods for cooking must be placed on the oven shelf, which is then placed on one of the runners fitted in the various types of ovens, following the guidelines below:

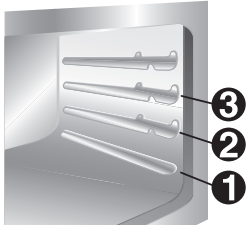

FOODS	RUNNER HEIGHT
Flat, thin pieces of meat	3
Rolled roasts	2 - 3
Poultry	2 - 3

8.6 Attention



- Grilling processes must never last more than 60 minutes.
- The oven door must be closed during grill and grill + rotisserie cooking operations.
- To prevent hazardous overheating, the appliance's glass lid must always be raised when using the oven or grill.
- Accessible parts may be very hot during and after use of the grill; keep children well away from the appliance.
- During rotisserie cooking operations, one of the pans supplied with the cooker should be placed on the bottom of the oven, on the bottom runners, to collect any grease and fat produced.
- When using the oven, remove all unused pans and shelves from its interior.
- During cooking, do not cover the bottom of the oven with aluminium or tin foil, and do not place pans or trays on it; this may damage the enamel coating. If you wish to use greaseproof paper, position it so that it does not interfere with the hot air circulation inside the oven.

8.7 Storage compartment

The storage compartment is in the bottom of the cooker, underneath the oven. To open it, pull on the top of the door.

Never use it to store flammable materials such as rags, paper, etc.; it is intended to take the appliance's metal accessories only.



Never open the storage compartment when the oven is on and still hot. The temperatures inside it may be very high.



Instructions for the user

9. AVAILABLE ACCESSORIES

The oven features **4 runners** for placing trays and shelves at different heights.

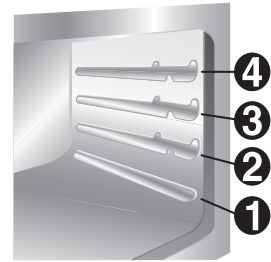

Oven shelf: for cooking food on plates, small cakes or roasts or foods requiring light grilling.

Tray grid: for placing on top of a tray for cooking foods which may drip.

Oven tray: useful for collecting fat from foods placed on the grid above.

Baking tray: useful for cooking cakes, pizza and confectionery.

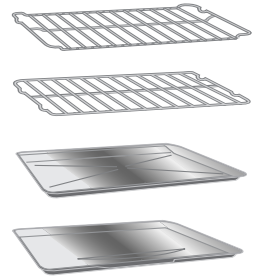

Not all accessories are provided on some models.

Accessories available on request

Original optional accessories can be ordered through our Authorised Service Centres.



10. CLEANING AND MAINTENANCE



Before carrying out any operation involving access to live parts, disconnect the appliance from the electricity supply.



Do not use a steam cleaner to clean a hob, oven or range.

10.1 Cleaning stainless steel



To keep stainless steel in good condition, it must be cleaned regularly, after each use of the cooker, after allowing it to cool.

10.2 Routine daily cleaning

When cleaning and caring for stainless steel surfaces, always use **only** specific products which do not contain abrasives or chlorine-based acids.

Instructions for use: pour the product onto a damp cloth and wipe over the surface, then rinse thoroughly and dry with a soft cloth or chamois leather.

Do not use harsh abrasive cleaners or sharp metal scrapers to clean the oven glass door since they can scratch the surface, which may result in shattering of the glass

10.3 Food stains or residues

Never use metal scouring pads or sharp scrapers; they will damage surfaces.

Use ordinary non-abrasive products for steel, with the aid of wooden or plastic utensils if necessary.

Rinse thoroughly and dry with a soft cloth or chamois leather.

Do not allow spills of foods with high sugar content (e.g. jam) to dry inside the oven. If they dry for too long, they might damage the enamel coating of the inside of the oven.



10.4 The burner caps, flame diffuser rings and burners

The burner caps and flame diffuser rings can be removed for easier cleaning; wash them in hot water and non-abrasive detergent, taking care to remove all deposits, and wait for them to **dry completely**.

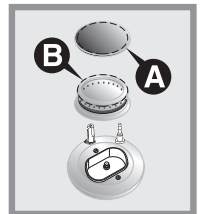

Replace the burner caps on their rings, making sure that the holes **A** are perfectly centered with the circular projections **B** on the burners.



Never wash these components in the dishwasher.

10.5 The plugs and thermocouples

For best performance, the ignition plugs and thermocouples must always be kept thoroughly clean. Check them frequently and if necessary clean them with a wet cloth. Remove any dry residues with a wooden toothpick or a needle.

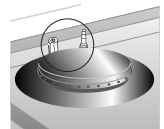



Instructions for the user

10.6 Cleaning the oven



For best oven upkeep clean regularly after having allowed to cool. Take out all removable parts.



Clean the oven grill and side guides with hot water and non-abrasive detergent. Rinse and dry.

10.7 Cleaning the door glazing

The glass in the door should always be kept thoroughly clean. Use absorbent kitchen roll; remove stubborn dirt with a damp sponge and ordinary detergent.



When cleaning, dry the appliance thoroughly to prevent water or detergent drips from interfering with its operation or creating unsightly marks.



Do not use abrasive or corrosive cleaners for cleaning the door glazing. (e.g. powder products, oven-cleaner sprays, stain removers and metal scouring pads).

Do not use rough or abrasive materials or sharp metal scrapers to clean the oven's glass doors since they may scratch the surface and cause the glass to shatter.



11. EXTRAORDINARY MAINTENANCE

The oven may require extraordinary maintenance or replacement of parts subject to wear such as seals, bulbs, and so on. The following instructions describe how to carry out these minor maintenance operations.



Before performing any operations requiring access to powered parts, switch off the power supply to the appliance.

11.1 Changing the light bulb

Remove the protective cover **A** by unscrewing it anti-clockwise; replace the bulb **B** with another of the same type (25 W). Re-fit the bulb protector **A**.



WARNING : *Ensure the appliance is switched off before replacing the lamp to avoid the possibility of electric shock.*

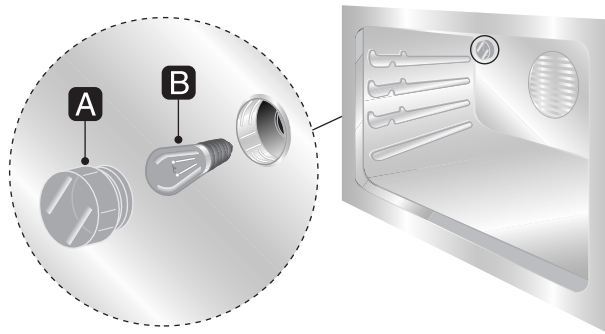

Use only oven bulbs (T 300°C).

11.2 Removing the door

Lift the levers **B** and Take hold of the two sides of the door with both hands near to the hinges **A**. Raise the door to an angle of about 45° and remove it. To reassemble, fit the hinges **A** into their grooves, then lower the door into place and release the levers **B**.

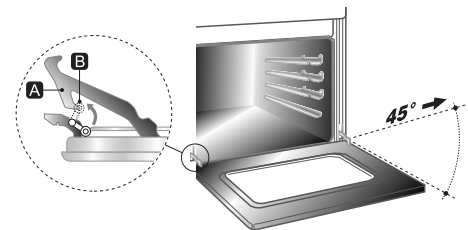

11.3 Removing the door seal

To permit thorough cleaning of the oven, the seal may be removed. Before removing the seal, take off the door as described above. Once the door has been taken off, lift the tabs at the corners as shown in the figure.

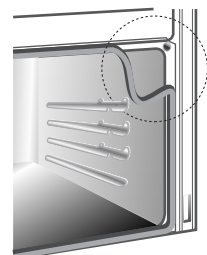



Instructions for the user

12. PROBLEMS AND CAUSES

Each of the following cases is caused by abnormal operation of the appliance and should be dealt with by a authorised person: please contact your local dealer or Service Center in case you detect any of these malfunctioning.

PROBLEM	CAUSE	WHAT TO DO
The flame is very long with bright yellow tips. Black deposits on the bottom of the pans.	Defect of comburent air or incorrect injectors.	Call service Center.
The flame is very short and noisy. The flame moves away from the burner ports.	Excess of comburent air.	Call service Center.
The flame extinguishes when the burner knob is set to the low flame position.	Incorrect adjustment of the minimum heat input or excess of comburent air.	Call service Center.
The valve knob is hard to rotate.	Gas valve worn out or needs lubrication.	Call service Center.
The cooker suddenly stops working during operation of the oven. The electronic programmer is not operating.	Overheating of the appliance	Let the appliance cool down: the safety thermal cut-out will self-reset when the temperature has decreased to correct value. Should the problem arise again, call the Service Center.



914774122/ B